

# *Rockmite ][ v3 Builder's Help*

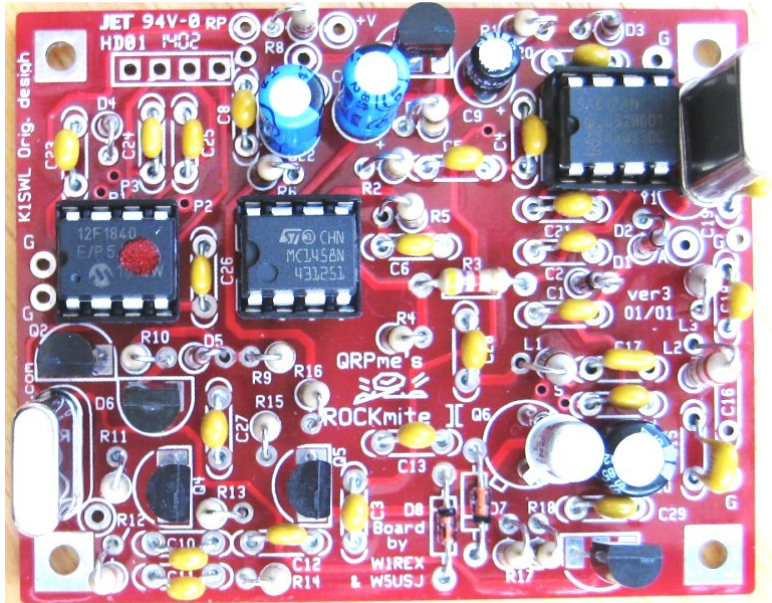

Shown with socketed Q6 and without required heatsink

## *Test, Operation, Trouble-shooting and Support Information*

### *Table of contents:*

<i>Description</i>	<i>Page</i>
Tools/ Soldering	2
Component Identification	3
Component Installation	4
Housing the Rockmite ][	5
Rockmite ][ Hookup	6
Troubleshooting	7- 10
Errata U1-5 to C4/C5 Trace Repair Mod	11

## TOOLS:

The following tools are recommended for construction of the Rockmite ][ board kit:

- Soldering iron – 25 to 50 Watts adjustable
- 60/40 clean flux solder, 0.025 dia., for connectors, switch terminals, and large gauge wire.
- Silver Bearing solder for component leads, (Radio Shack #64-035E, .015 dia.)
- De-soldering braid (Radio Shack #64-2090B).
- Diagonal cutters

The following may be useful:

- Tweezers
- Illuminated magnifying glasses or lenses.

## STATION BASICS:

- **Headphones:**

Low-impedance (personal CD-player type)

- **Antenna:**

50-ohm nominal at frequency of interest  
(typically- a *matched dipole*)

- **DC Power:**

11-14V DC- regulated or battery

- ~25 mA (receive)
- ~200 mA (transmit)

## COMPONENT IDENTIFICATION:

### RESISTOR COLOR CODES:

Resistor color codes are given in the parts list. Radio Shack's Color-Code Guide, #271-1210, or the ARRL Handbook will help. If you're not sure, verify the resistor values with a multi-meter before installing.

For what it's worth, roughly 8% of the male population is red/green color blind. If you're one of these, you should be verifying all resistors with a multi-meter before installing them. An illuminated magnifying lens help to read those tiny numbers

The Rockmite ][ board is double-sided and all holes on the board are plated-through. This means that you

do *not* need to solder on the top side of the board unless noted otherwise (usually wire or peripherals).

## SOLDERING SKILLS

Hopefully this isn't your first experience with a soldering iron. If it is, though, or this is your first solid-state project, here are some tips to ensure your success:

- Soldering Iron:

Use a small iron **in the 25-watt class (such as a Radio Shack #64-2070)** and keep the tip clean. A better choice is the Solomon SR-976 adjustable temp solder station. Use a soap-free metal shavings scouring pad or coarse steel wool to clean the tip frequently as you work.

Apply as much heat as is needed to get a good joint. Get on and off the joint quickly. A small vise to hold the printed-circuit board may make soldering easier.

Touch the clean soldering iron tip to the PC board trace and the component lead simultaneously. Within a second or two, apply solder and you'll see the solder flow onto the junction. Withdraw the solder and then the soldering iron; total time per joint approximately 5 seconds.

**Avoid the temptation to load solder onto the joint until no more will fit!** This is an invitation for trouble, as solder bridges may form across the closer trace separations. Here's what the correct and incorrect joint treatments look like:

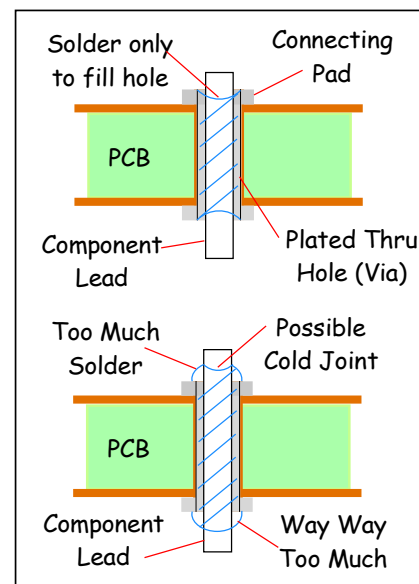

PLEASE READ THE SECTION BELOW BEFORE REMOVING ANY PARTS FROM THE BOARD

Uh-oh! Sooner or later, you may need to remove a part installed in the wrong location, or perhaps pull a component for troubleshooting purposes.

Using de-soldering braid, lay the end of the braid down on the joint to be cleaned and press the soldering iron tip over the braid. Within several seconds you'll see the braid begin to wick up solder from the joint. Remove the braid and reapply a new section as needed until the joint is clean. It may be necessary to pull the component out from the top side of the board while heating the joint. Leave the iron tip on the board only as long as necessary to do the job- the PC-board traces will eventually delaminate (peel off) if overheated.

If that still doesn't do the job, it may be necessary to cut the offending part off on the top side and pull the remaining leads through with pliers. Contact QRPme.com for replacement parts if necessary.

If you need to remove a transistor, sacrificing the part by snipping it off on the top side of the board is highly recommended. The leads are best pulled out singly to minimize the risk of lifting pads.

After removing a component from the board, the through-hole will probably still be blocked with solder. Use a dissecting needle or dental probe (explorer), apply heat to the probe and the board trace simultaneously until the tool pushes through. Lacking either of these tools, a round wooden toothpick works well also!

Alternately, carefully clean out remaining solder with an 0.029 dia bit using a hand-held pin vice.

#### REFERENCE DESIGNATORS:

Each component on the schematic is uniquely identified with a reference designator.

#### COMPONENT IDENTIFICATION:

- The figure below illustrates pin-out for U2 and U3. The "pin 1 at lower left" convention applies to all Dual-In-line-Package (DIP) ICs. **Please note: if you install the sockets backwards- leave them!**

In that case, ignore the socket orientation when installing the IC with its dot or notch to the left as shown.

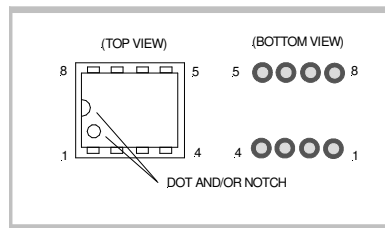

NOTE: SEE PAGE 11, *ERRATA*, FOR JUMPER INSTALLATION BETWEEN U1-5 AND C4/C5 JUNCTION.

- Resistors and RF chokes

This manual describes the color coding for all resistors and RF chokes. Only the first three bands are described, the fourth band is a tolerance code, typically gold (=5%) for resistors, and is not listed. All resistors are 1/4W 5% carbon film types, RF chokes are also an axial (leads out of each end) component but can be distinguished by their larger size.

- Capacitors:

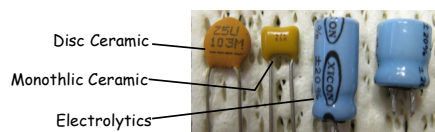

Here's the general rule for capacitor nomenclature:

If 3 digits are printed on the capacitor, the first two are significant figures and the third is a multiplier.

Examples:

$$'471' = 47 \times 10^1 = 470 \text{ pF}$$

$$'103' = 10 \times 10^3 = 10,000 \text{ pF} = .01 \text{ uF}$$

Letter suffixes: J=5%, K=10%, M=20%.

*Please: If you're looking for a '104' monolithic cap, be sure to inspect both sides of the caps before concluding we gave you the wrong value! Use the lighted magnifier!*

Note: If these parts are supplied with a 0.1" (2.5mm) lead-spacing for installation in a board hole-spacing of 0.2" (5 mm), bend the wire leads gently to spread the spacing. Avoid sharp bends right at the wire-lead exit from the epoxy case; this may cause component damage/failure.

## Diodes:

Since the lettering on these is teeny-weeny teensy-tiny, diodes in each section may be equated by quantity to corresponding entries in the parts list. For positive identification, *use the lighted magnifier!*

- Extra information on components

There's often extraneous information marked on components. Examining a sample IC, find, e.g., "MC1458P1 KKJK 8949". You care only about the '1458' or other specified markings. *If the LoM specified a capacitor '104' and you find the correct number of parts, but marked "104M", for instance, those are them! "Use the Force, Luke".*

### Building instructions:

All parts installed on the PC board should be fully seated unless otherwise noted in the assembly text.

**All components are installed on the side with the silkscreen printing- this is the 'top' side of the board.**

### Static-sensitive Components:

**The 2N7000 transistors and the 12C508A IC (U3) are static-sensitive.**

- Keep these parts in the antistatic bag until you're ready to install them and handle them no more than necessary.
- Ideally, you've got a grounded-tip iron, but if not- After the part is installed on the board and before soldering, touch the iron tip to shack ground (if available) or to a PC-board ground point.
- Avoid placing these components on plastic or paper.

- Diode Installation:

Some of the diodes are bent for "upright" installation on the board. Installation polarity is as shown below. Be sure to note the orientation of the silkscreened circle on the board and install the diode body over this hole. The cathode (banded) end of the diode is oriented at the top. For diodes which are installed 'lying down', match the banded end to that shown on the silkscreen.

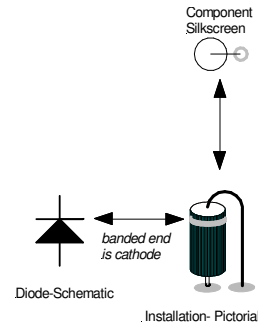

- Resistor installation:

Most resistors are likewise installed in 'hairpin' fashion. As with the diodes, try to match the mounting orientation shown on the drawing. (If mounted as shown you've got better troubleshooting access to circuit points from the top side of the board.) Orientation of color bands on resistors and other nonpolar devices is not critical.

- Installing IC sockets:

The "notch" or dot at one end should be oriented as shown in the pictorial drawings. Double-check orientation before soldering. *A suggestion-* solder down two opposite corners of each socket, and then go back and press a fingertip on the socket from underneath while reheating both connections in turn. You may then solder the remaining pads. This precaution ensures that the socket is well-seated on the PC board.

### Before the "Smoke Test":

Inspect your work to ensure there are no solder bridges or unsoldered joints. Check to see that the ICs are mounted in their proper orientations, or install them if you haven't already done so.

You are strongly advised to hook up the Rockmite ][ and test it out on the bench before putting it into an enclosure. You'll save yourself a bunch of disassembly work if you need to get at the board for troubleshooting.

## Rockmite ][ Mechanical Details:

The board itself may be mounted in an enclosure at the board's four corners, using #4 machine screw hardware. #4 spacers should be used to separate the PC board from the enclosure by 1/8" or more. (#4 hex nuts are an acceptable substitute for spacers.)

Alternately, you can "thread-form" the corner holes with a 6-32 screw and use them as a nut. Carefully start a screw in the hole and drive the screw; maintain vertical. Nickel-plated screws work the best. Don't use thread cutting screws as that will remove the plating from inside the hole. Tighten snugly but don't force to avoid stripping.

The mounting holes are in the form of a rectangle with the hole center spacing measuring 2.20" by 1.70". *If you have the enclosure in hand before populating the board with parts, it's helpful to lay the blank board down in the enclosure in its planned position. Restrain the board with one hand while tracing the hole outlines on the enclosure with a sharp pencil. (See below about center-punching)*

### Enclosures:

Enclosures may be found in a variety of styles. Radio Shack offers several types of metallic enclosures. I'd especially recommend Hosfelt Electronics, Inc., who carry enclosures offered by a number of companies. The 'LMB' line of enclosures, in particular the LMB CR-425, is offered by many mail-order companies and pricing is economical. Ten-Tec, Inc. also offers a complete line of enclosures, and they support small orders as well!

'MityBox' offered by American Morse.  
<http://americanmorse.com>

QRPme.com Rockmite ][ Custom PCB enclosure. Sides fashioned from PCB material, solder-masked with all peripheral part holes plated through. Easy assembly using the supplied connectors and controls.

### Metalworking tips:

**Plan** all enclosure hole placements **carefully!** You won't enjoy discovering an interference between a connector and one or more on-board-components.

Mark all holes with a center punch (or even a sharp nail) before drilling. Nothing says 'klutz' like power-drill marks skittering across an enclosure surface! The

punched indent gives the drill a slip-resistant starting point. Also it's often useful to drill a small pilot hole.

Trim ragged edges on the drill holes with a knife. This may also be done neatly with a sharp oversized (~3/8") drill. *Careful- you want to chamfer the hole edge, not drill clear through!*

### 'Low-budget' enclosures:

The QRP community has embraced the ubiquitous (at least in the US) Altoids mint tins as an enclosure for small projects, and the Rockmite ][ is 'Altoids-compatible'. You can't beat the price on these, and the rig smells nice when you're done! *If you're using one of these, be aware that the metal is prone to tearing because it's so thin. Be sure to use a wooden backing-block when drilling through this material. If you prefer, small holes may be enlarged by working carefully with tapered reamer, step drill or a round ('rat-tail') file.*

### Connectors and controls:

Here are the part numbers for the supplied connectors and controls. *Feel free to substitute.*

AF (headphone) and Key jacks:  
3.5mm 3-conductor (stereo) jack: Mouser # **161-3402**

Antenna jack- BNC bulkhead : Mouser # **161-9323**

Power coaxial jack: Mouser # **163-4304**

(mating) power plug: Mouser # **1710-2131**

switch: Mouser # **10PA019**

gain pot: (optional- audio) Mouser # **31JN601**

Mouser Electronics- [www.mouser.com/](http://www.mouser.com/)

*Note: These connectors and controls for the Rockmite ][ are provided as part of the Rockmite ][ board kit.*

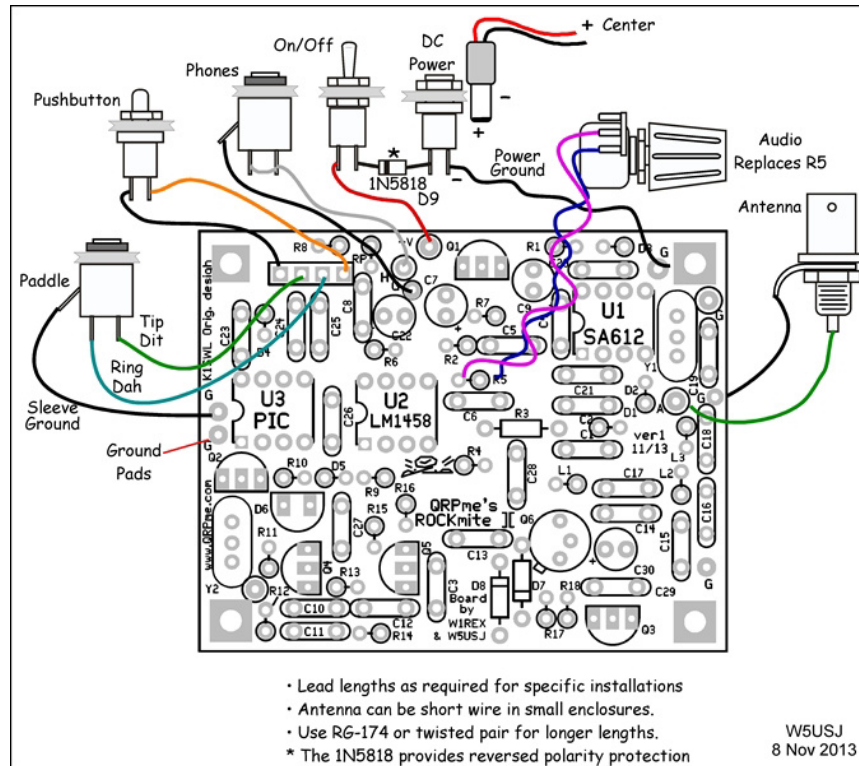

**Design modifications / things to try:**

- **Side-tone:**

Side-tone level can be altered by changing the value of C8 Note: the 'raspy' nature of the Rockmite II side-tone is due to the square-wave nature of the signal. One or more R-C networks (series-R, shunt-C to ground) in the path [from PIC pin 5 to C8] will soften the tone. A good starting point for this filter is 10 ohms/ 10 uF.

- **Volume control:**

Changing R5 to a variable resistance provides an audio gain control. [ Remove or don't install R5 (1M) from the board and wire its two circuit-board pads to a 1 Meg ohm potentiometer- use the pot center terminal and one of the remaining terminals. Keep lead leads short.] See the drawing above.

- **Polarity Protection**

A 1N5818 is supplied with the Rockmite II kit. Be sure to use the part with your

installation. See the drawing above. It's easy to slip up while testing and connect the supply voltage backwards. It's no fun trying to figure out which parts were damaged when attempting repairs

- **Reduced Supply voltage**

The Rockmite II will run at much reduced power on a 9V battery if R1 and R8 are changed from 1K ohms to 470 ohms. This change increases (receiver) current consumption from ~25 mA to 40 mA when using a 12-14V supply.

Note: In the following trouble-shooting section, the transmitter oscillator must be working for the receiver to work. The receive local oscillator (BFO) is derived from the transmit oscillator, connection B on the schematic.

## Troubleshooting the Rockmite [[:

The "bugs" you're most likely to encounter often turn out to be caused by the simplest of problems. If your "Rockmite [[: doesn't play, here are some general troubleshooting guidelines.

### General guidelines:

Check once more for solder bridges and missing solder joints. Probing a suspect section of the circuitry with a fingertip or insulated tool will sometimes bring a stubborn circuit to life- if so, check again for a bad connection!

**Of the problems most often found, about 85% are caused by cold solder joints, 5% by excessive solder and solder bridges and 5% due to incorrect resistor installation. That leaves only 5% for all the other problems put together.**

- Ensure that the ICs are installed in the correct location and with the correct orientation.
- Likewise ensure that the transistors and all diodes are installed with the correct orientation.

### Receiver troubleshooting: (*power applied*)

Remove key/keyer input plug before proceeding

- 1) Verify that the following DC voltages (use a multi-meter set to 'DC volts' are present on U2 as shown below. Expect up to 20% variation in your results- you're looking for things that are broken, and they'll clearly deviate from the given values.

#### U3 (PIC12C508A)

Pin #	Voltage	
1	4.7 or 5.1V	lower left (topside of board)
2	0V	
3	0V or ~5V	* should alternate with each tap of the switch.
4	~5V	
5	0V	
6	~5V	
7	~5V	
8	0V	

If pins 4, 6 and 7 are not at ~5V, make sure their connections to the key/keyer jack and the switch are not inadvertently grounded. **You must use a**

**normally-open switch (contact is closed only when depressed).**

- 2) Verify that the following DC voltages (use a multi-meter set to 'DC volts' are present on U2's pins as shown below.

#### U2 (LM1458)

Pin #	Voltage	
1	don't care	/ lower left (topside)
2	don't care	
3	don't care	
4	0v	
5	4-5V	
6	4-5V	
7	4-5V	
8	12v	/upper left (topside)

If pin 8 does not show a DC voltage roughly equal to the DC supply voltage, either DC voltage is not getting to the board (double check the path) or R6 is incorrect value/ open connection.

Pin 5 gets its DC voltage from pin 4 of U1 through resistive voltage divider R3/R4. If this is absent, U2 pins 6 and 7 will also be wrong values. (See 'U1' in that case)

If pin 5 is OK but pins 6, 7 are wrong, double-check the continuity (power off, meter on 'ohms') between pins 6 and 7. It should be 1 megohm (or variable between 0 and 1M if you've installed an optional AF gain pot.)

**U1:** Verify that the following DC voltages (use a multi-meter set to 'DC volts') are present on U1 as shown below.

Pin #	Voltage	
1	1.4V	/ lower left (top side of board)
2	1.4V	
3	0V	
4	4-5V	
5	4-5V	
6	4-5V	
7	4-5V	
8	5.1 or 6V	/upper left

*/ Trouble spots:*

**No receiver audio?- read on...**

1) Using a small screwdriver tip, probe U2 pin 6. You should hear a distinct hum in the headphones.

**No joy?**

- open connection between U2-7 and headphone jack
- head phone jack incorrectly wired/shorted to ground
- Q1 failed. This may be tested by temporarily adding a jumper between the two end pads for Q1- this closes the connection and should allow full audio through to the headphone jack.

2) Using a small screwdriver tip, probe U1 pin 2. You should hear distinct shortwave noises (possibly voices) in the headphones.

**No joy?**

- See the 'Local Oscillator' section below
- make sure the DC voltages above are correct
- read and heed the note about 'trouble spots'

3) Receiver- *other*

- If touching pin 2 of U1 yields shortwave sounds but touching the D1, D2 junction yields nothing, look for an open connection around Y1 or a short to ground or misplaced component around D1/D2.

Check DC continuity on L2 and L3- this is done "in-circuit" with a meter set to 'ohms' and power removed from the board. These devices should read several ohms or less. **SWL Rock-Mite20 builders:** *Check L2/L3 color codes closely- a limited number of kits went out with incorrect values for L2, L3.*

- "When I unplug the key, the rig starts transmitting"

You used a closed-circuit type jack. *You chose... poorly.* You need a 3-conductor stereo jack, or if using a monaural connector- an open-circuit type.

**Local Oscillator:**

The local oscillator runs continuously. Troubleshooting verifies correct DC biases at transistor Q4 and checks for oscillator function

DC voltages: check DC voltages at the follow locations:

Q4-C (upper end- or lower end of C108): 12V

Q4-B (middle lead or R12 lead): 3-5 V  
Q4-E (lower end ) 3-5 V

These last two readings may vary considerably due the presence of RF on the oscillator stage. Your meter may also indicate AC values, but the results are not trustworthy- your meter is not designed for accurate interpretation of RF signals.

You should be able to hear the Rockmite ]['s local oscillator by tuning another ham-band rig close to the Rockmite ]['s operating frequency. If not, and the DC voltages above are OK, suspect the connections to Y2, C10,C11 and D6.

**Note:** The local oscillator frequency shifts ~700 Hz between 'transmit' and 'receive'. You should be able to hear this shift in the other ham-band rig. If not, ensure that the network comprising Q2, D5 and related resistors are providing a voltage shift between 0V and the rated D5 zener voltage (no D5 with the 80m RM ][ ). This voltage should change between those two values with each tap of the switch and also with each dot or dash being sent.

**Transmitter troubleshooting-**

Add a key/keyer paddles and make measurements in the key-down state. One of the two following statements should be true:

If a straight key is in use, either pin 6 or pin 7 is grounded and the other pin swings from ~5V(key-up) to 0V (key-down).

(or)

If a keyer paddle is in use, either pin 6 or pin 7 is at 5V and the other pin swings from ~5V(key-up) to 0V (key-down). If both inputs are grounded simultaneously, U3 generates an alternating stream of dots and dashes at pin 2.

**Voltages at U3 (PIC12C508A)**

Pin #	Voltage	
1	4.7 or 5.1V	/ lower left (topside)
2	0V (key-up 5V (key down- straight key mode)	<i>or</i> key-down in keyer mode: alternating 0V/5V
3	0V or ~5V	* should alternate with each tap of the switch.



This pin alternates between 0V and 5V in time with the voltage on pin 2. It may be either high (5V) or low (0V) during key-up depending on whether or not you've tapped the 'switch' to change frequency.

- 4 ~5V switch 'open'/ 0V switch 'closed'
- 5 2.5V (key down)  
This pin ('side tone') rests at 0V during key-up and provides an 800 Hz 5V p-p waveform during key-down.
- 6 ~5V key-up/ 0V key-down
- 7 ~5V key-up/ 0V key-down
- 8 0V

#### Driver (Q5) Integrity:

Check the key-down DC voltages on Q5:

- Q5-E (R17 lead): ~0V
- Q5-B (R15 lead) ~3-5V
- Q5-C (R16 lead) ~10V

In the key-up state, the above points will measure in the 8-12V range. If the U3 voltages are OK but no change to the lower voltages listed above, suspect Q3 (2N7000)- shorting C110 temporarily to ground will test this theory and should allow proper readings at Q5.

#### PA (Q6) Integrity:

Check the key-down DC voltages on Q6:

- Q6-E (R18 lead): ~0V
- Q6-B (D8-banded end ) ~1V
- Q6-C (transistor case) ~5-10V\*

\*If the rig is working normally, the reading at the collector will be somewhat indeterminate because of the large RF signal present there.

~12V means the supply voltage is getting to Q6 but there is no RF drive signal getting to the base.

**No voltage getting to Q6?** Check DC continuity on inductor L1.

Low or no RF output:

- Check DC continuity on inductors L2 and L3. Double check the component color-codes carefully per the values given in the parts list.

- Check for correct values of capacitors installed at C15,C16 and C17.
- Check integrity of connection to antenna jack.
- Open connection to antenna jack.

### Other troubleshooting issues:

#### AC Hum-

- Make sure Y2's case is grounded.
- The Rockmite ][ has a lot of audio gain. You may experience difficulty when using an unregulated power supply or 'wall-wart' to power the rig. A regulated supply will help considerably in this regard. If in doubt- try a battery supply- you may use a 9V battery temporarily to check out the difference.

#### 'Howl' in headphones

*(Make sure you're not in straight-key mode with the key-down- that'd be the side tone.)*

The combination of high audio gain and wire lead treatments can yield an audio oscillation or 'howl', although this has not been reported often. The following guidelines apply:

- If using a battery supply, make sure it's reasonably well charged. A nearly-exhausted battery may cause 'howl' or 'motor boating'.
- provide separation between wires run to and from the Rockmite ][ board and the board components- close lead proximity affords more chances for unwanted signal crosstalk
- where wires do need to cross, keep them at right angles to one another to minimize the coupling
- don't count on the enclosure itself to provide ground -return continuity. It may be helpful to run a ground- return wire from the board to the headphone jack ground lug and from there to the DC power return. If you do this, continue to use a wire from board ground to the main DC power return. There are ground pads along the edge of the PCB providing separate peripheral grounds.
- If a length of RG-174 coax is used to connect the antenna, ensure that the ground braid is used. Connect the rig end to the A antenna pad and shield to the ground pad Also ensure that the

other end makes proper connections to the antenna jack middle pin and ground lug. See the drawing on page 6.

## Broadcast pickup:

There are two potential issues with the Rockmite ]]:

### Shortwave broadcast:

This will be more likely during the evening hours. Despite the presence of the front-end crystal filter, some SWBC may occasionally be heard. A fix involves reducing the signal levels getting to U1- see the second recommended gain-control modification (page 6). The use of an antenna tuner will also assist in reducing the out-of-band RF energy getting to U1.

### Local AM broadcast:

This is more likely during daylight hours when local AM stations are on the air. Install a 1K resistor across the ungrounded D1/D2 pads. **Note: this fix does not help with shortwave broadcast.** *[This unwanted pickup was not evidenced at the SWL QTH, nor with early SWL Rock-Mite samples. The fix was tested successfully at the ARRL lab, located within two miles of several 5KW AM broadcast stations.]*

### Very low volume:

This is a minimalist transceiver, so it won't provide ear-splitting volume. Even so, with a good antenna and headphones you should have little trouble hearing signals. If everything else checks out, consider the following:

**Antenna:** This'll be a resonant antenna, 50 ohms nominal. The most familiar example of this is a coax-fed dipole. If the antenna is non-resonant (random wire, etc.), a tuner is typically used to make the antenna 'look like' 50 ohms at the rig. High SWR is a problem and can cause excessive Q6 heating and permanent damage. *Use a dummy load for testing. Ensure the antenna is a close match or use a tuner with an absorptive bridge such as the Dan Tayloe tuning indicator.*

**Headphones-** This is a low-impedance stereo type, such as are widely available for personal CD players. These are available in a variety of price tags from \$2-up. You generally 'get what you pay for'- avoid the cheapest ones. \$10-20 gets you a decent pair, and if there are specifications on the package, look for a sensitivity spec of 104 dB/mW or better.

*And a final caution related to audio output: You'd be surprised how often that reports of very low audio are traced to use of incorrect audio jack or plug types- you won't hear much with the audio output shorted to ground!*

"Strange but True"- In general, the ICs themselves shouldn't be prime suspects during the troubleshooting process. Despite their complexity, they're very reliable. Only 1 part for every thousand or so shipped have needed replacement!

- For parts replacement or with questions contact:

Rex Harper, W1REX  
e-mail: Rex Harper <tunacankits@gmail.com>

Factory troubleshooting is not available for the Rockmite ]]. *Let's get real- this is a \$40 transceiver, and repair is just not economical.* User groups and private individuals are available to help if needed.

### Crystal Grounding

Here's another method of grounding crystals that allows crystals to be grounded and still plug into a SIP socket

- Install and solder all three pins of a SIP connector
- Trim the crystal leads to a length of 3/16 inch
- Plug one clipped lead into the center hole of the socket
- Bend the lead over 90 degrees
- Plug the crystal into the socket
- Bend the wire up 90 degrees to touch the crystal
- Using adequate heat and time short as possible solder the lead to the edge of the crystal.

Result: A removeable crystal with grounded case

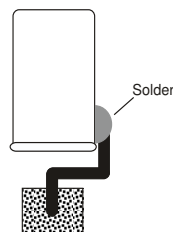

W5USJ Drawing 10 Nov 2013

This document is based on the original RM Helps Supplement by Dave Benson, K1SWL.  
Edited by: Chuck Carpenter, W5USJ  
Copyright 2013: Rex Harper, W1REX, QRPme.com  
All rights reserved.

## Errata

### U1-5 to C4/C5 Trace Mod

Note:

Only 1 lead on the two components is soldered for this illustration. This so the parts could be easily removed and the pads cleaned out.

Procedure:

Cut or ensure that the trace between U1-5 and U1-1 is cut.

Use care that no adjacent traces are cut.

Position the 0-Ohm jumper centered between U1-5 and the end pad of C4 at the C4/C5 junction. A small piece of clear tape would help hold the jumper in place.

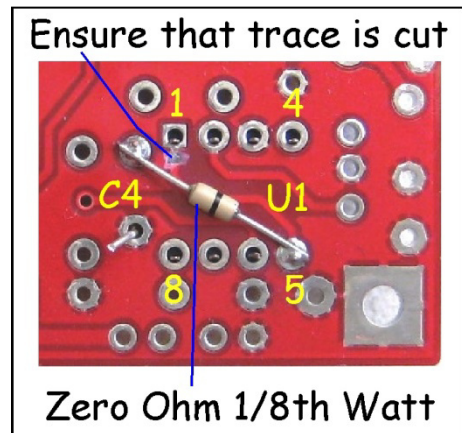

Solder (tack-solder) the jumper at the U1-5 end and trim the wire. Ensure that no shorts to other pins or pads has occurred.

Connect the other end of the jumper to the C4 pad and trim the wire. Remove the tape if used.

Continue the assembly per the *Builders Guide*